

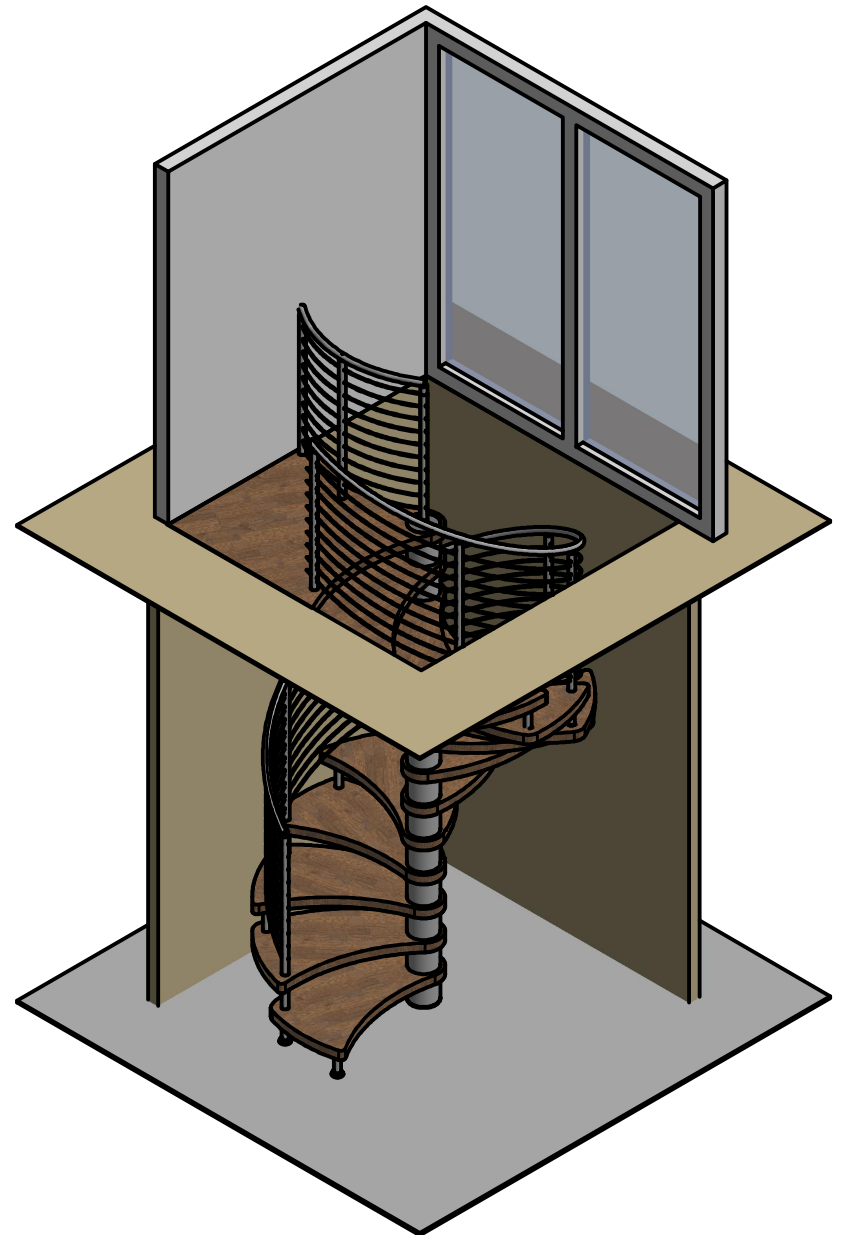

Interior Spiral - Part Dimensions

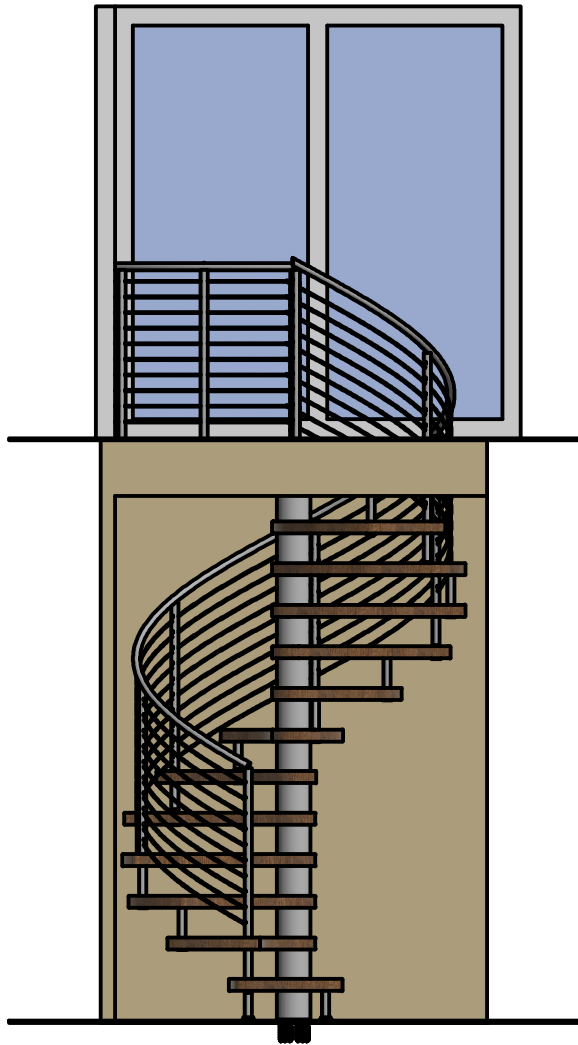

	Part Name:	Tolerance: .X" +/- .03" .XX" +/- .015" .XXX" +/- .005" X/X" +/- 1/16" X° +/- 0.5° Or as Specified
	Part Description:	
Sheet 1 of 6	Material:	

System Features:

- Tread Min. Width: 26"
- Tread Max. Width: 48"
- Tread Thickness: 2.5"
- Tread Min. Rise: 7"
- Tread Max. Rise: 9.5"
- System Min. Radius: 180 Deg.
- System Max. Radius: n/a
- Min. Headroom: 6' 6"

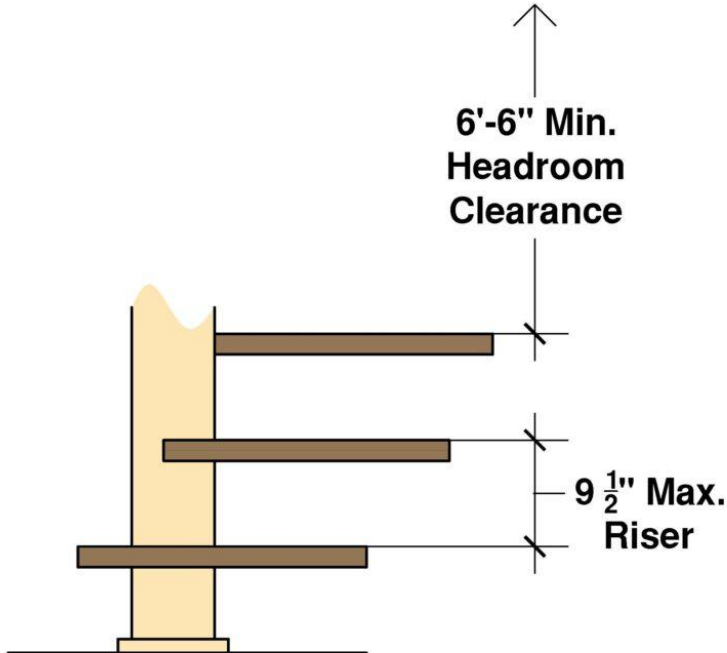
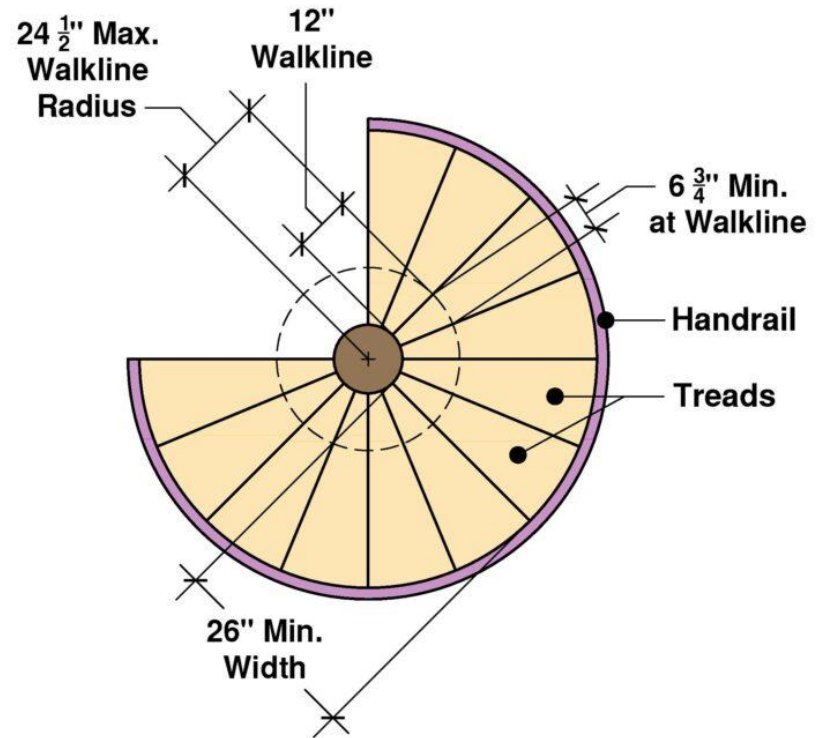

	Part Name:	Tolerance: .X" +/- .03" .XX" +/- .015" .XXX" +/- .005" X/X" +/- 1/16" X° +/- 0.5° Or as Specified
	Part Description:	
Sheet 2 of 6	Material:	

Interior Spiral - Mounting Plate

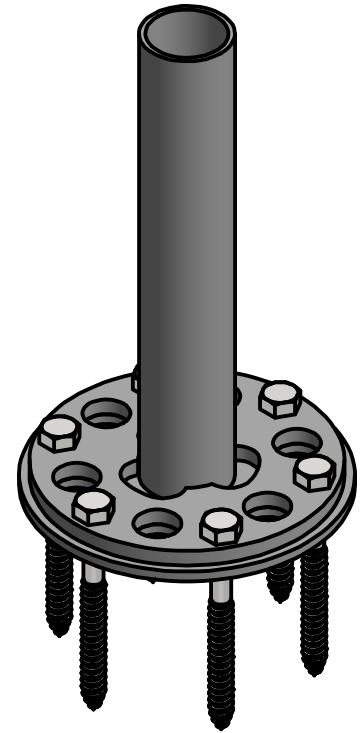
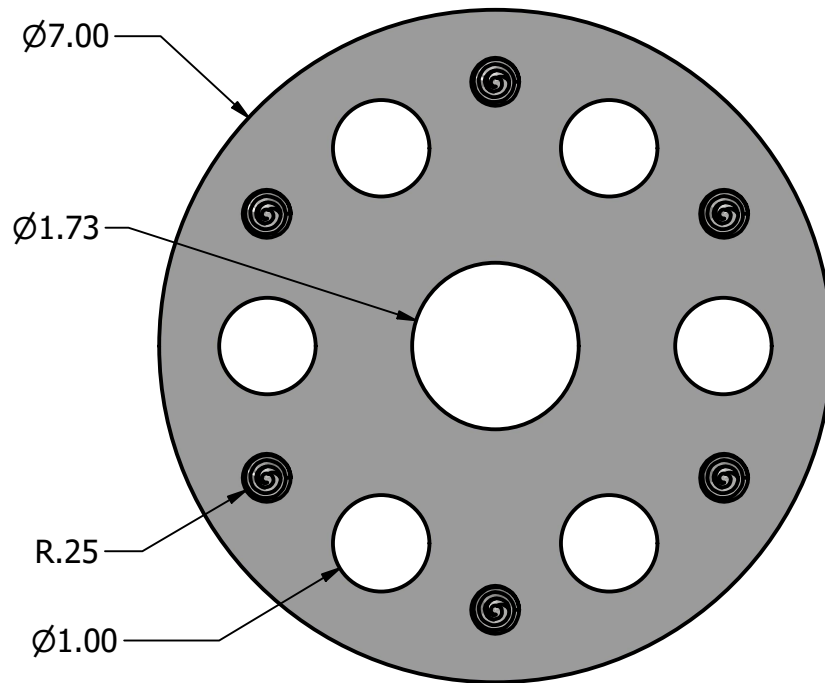

	Part Name:	Tolerance: .X" +/- .03" .XX" +/- .015" .XXX" +/- .005" X/X" +/- 1/16" X° +/- 0.5° Or as Specified
	Part Description:	
Sheet 3 of 6	Material:	

Interior Spiral - Center Tube Mounting

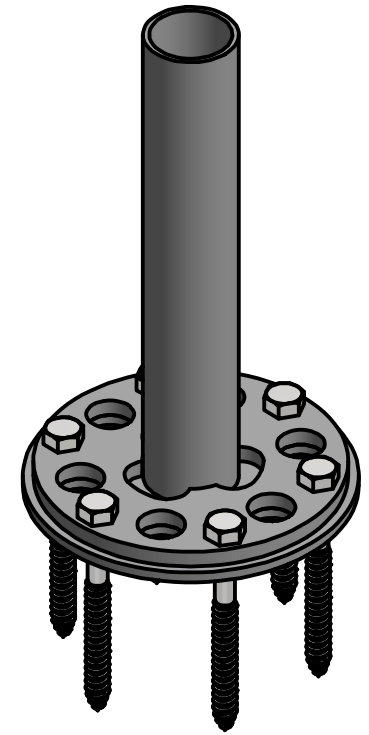
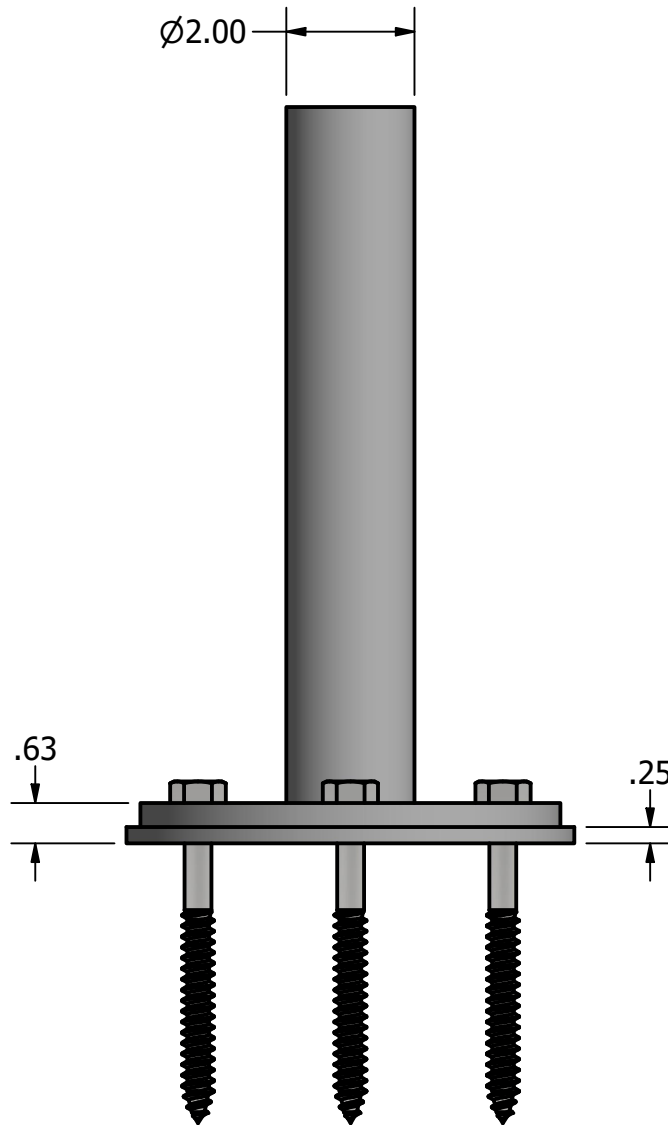

	Part Name:	Tolerance: .X" +/- .03" .XX" +/- .015" .XXX" +/- .005" X/X" +/- 1/16" X° +/- 0.5° Or as Specified
	Part Description:	
Sheet 4 of 6	Material:	

Interior Spiral - Center Support

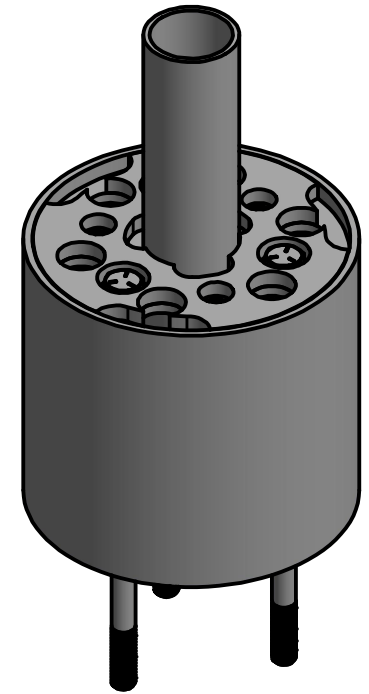
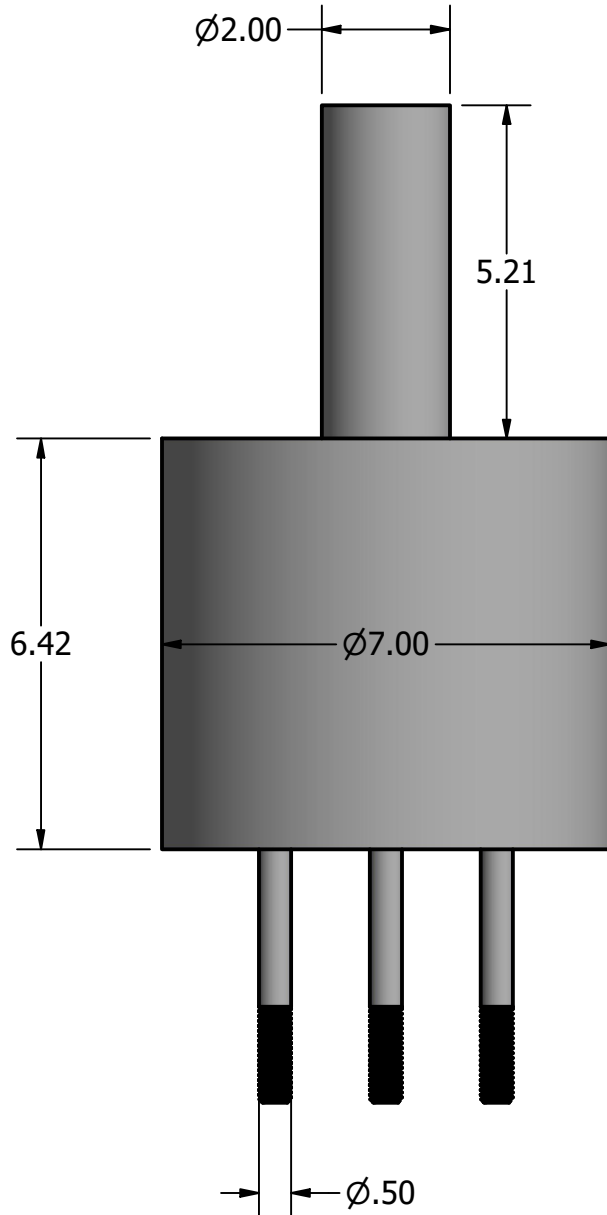

	Part Name:	Tolerance: .X" +/- .03" .XX" +/- .015" .XXX" +/- .005" X/X" +/- 1/16" X° +/- 0.5° Or as Specified
	Part Description:	
Sheet 5 of 6	Material:	

Interior Spiral - Tread Support

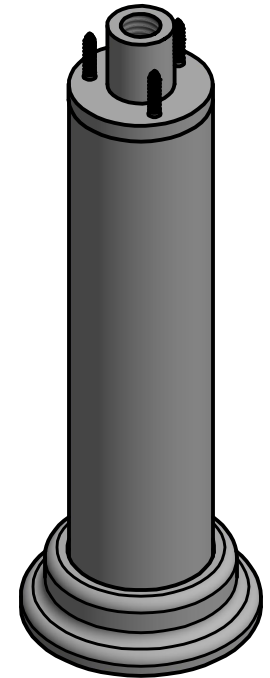
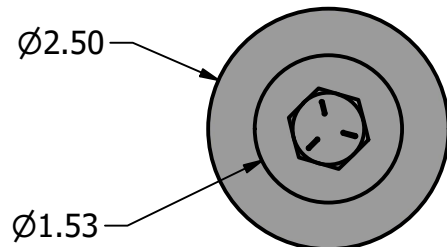
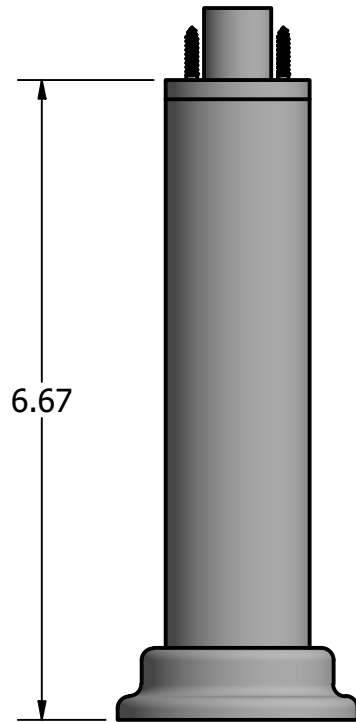
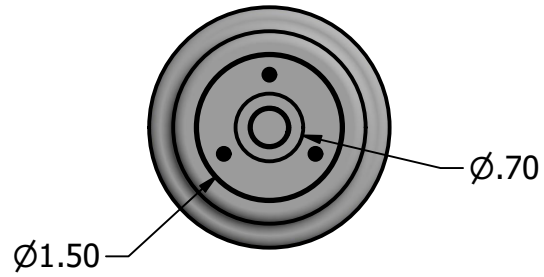
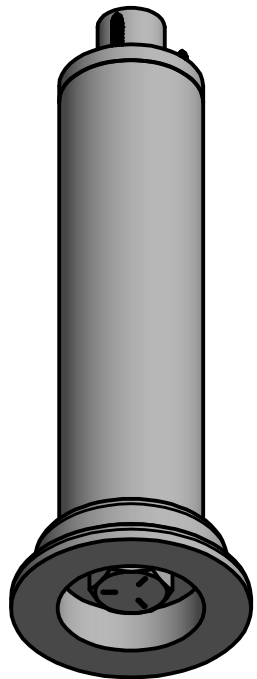

	Part Name:	Tolerance: .X" +/- .03" .XX" +/- .015" .XXX" +/- .005" X/X" +/- 1/16" X° +/- 0.5° Or as Specified
	Part Description:	
Sheet 6 of 6	Material:	